

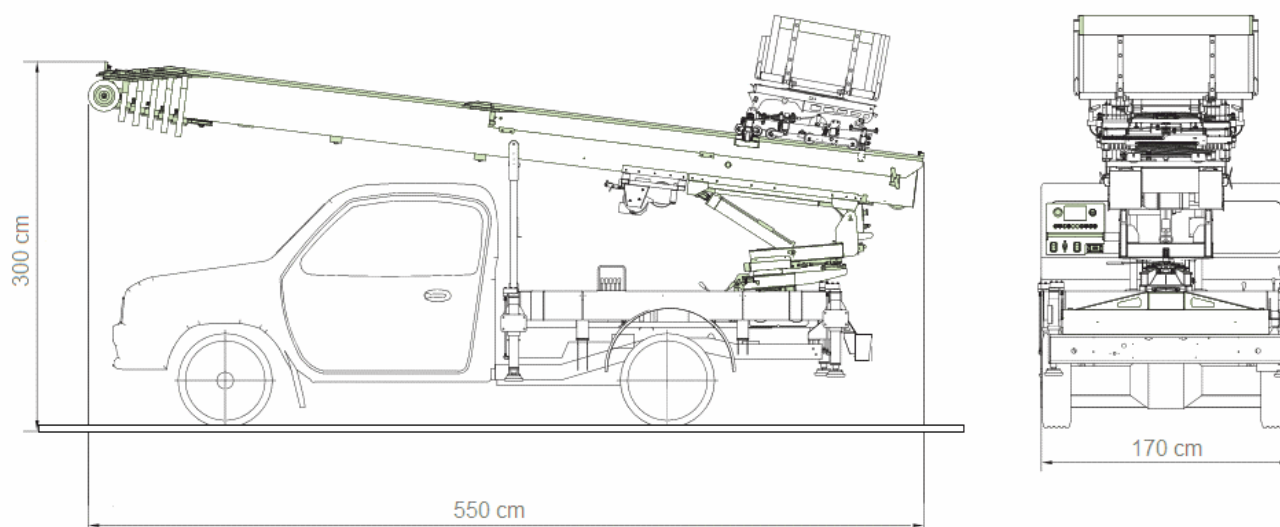

## Caratteristiche tecniche autoscala 26 metri



## Caratteristiche tecniche cesta di carico

