

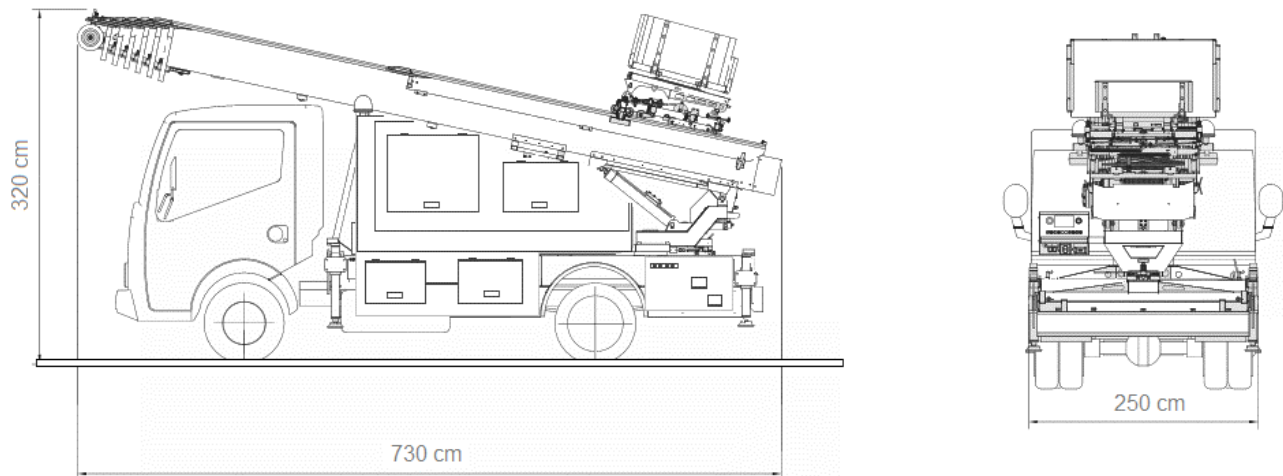

Caratteristiche tecniche autoscala 45 metri



Caratteristiche tecniche cesta di carico

